



[www.claypaky.it](http://www.claypaky.it)



ENGLISH

# ALPHA 700 | 800

Profile | Spot HPE | Beam | Wash | Profile | QWO

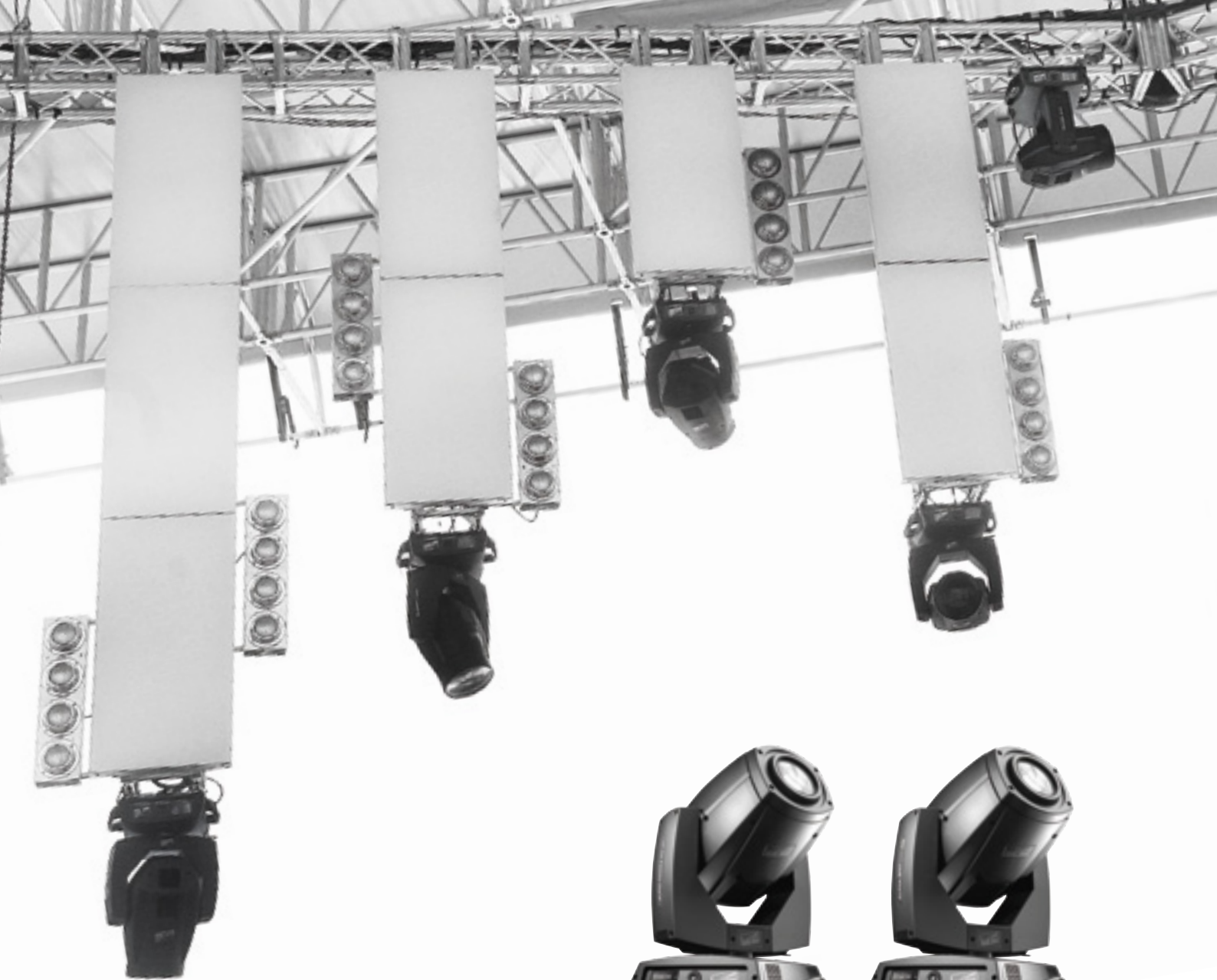

Alpha Profile 800 ST



Alpha Spot QWO 800



Alpha Profile 700



Alpha Spot HPE 700



Alpha Beam 700



Alpha Wash 700



## Alpha 800 and 700: where emotion and reason converge

For many years, new lights were mainly chosen for their novelty value, in other words their ability to arouse emotions owing to new functions and increased performances.

Today however moving head lights are mature products, most of their functions have been standardized, new effects are increasingly marginal and they are less and less likely to seduce users, who are in turn ever more aware of and attentive towards substance.

Clay Paky's rational response to this mature market are the new Alphas 800 and Alphas 700, the result of meticulous engineering that puts consolidated user requirements in the foreground.

The Alpha 800 and 700 moving heads are the epitome of the most advanced technologies in every field. Precision micromechanics and optics, powerful reliable electronics, advanced lighting engineering and an ergonomic and pleasant design all converge to create a family of compact professional lights that fascinate for the rationality of the solutions adopted and the way they improve technical practice.

However they are not just the perfect rational option. They also fully satisfy the requirements of an emotional choice. Ease of use comes with a surprising range of powerful functions, with no compromises. The small body of the Alpha 800 and 700 is a precious magic box from which an unexpectedly bright light emerges with a range of effects and controllability that can only be found in the most powerful and expensive latest generation lights.

The Alphas 800 and 700 are the most modern luminaires on the lighting market today. They are rationally designed and built to create emotion in all fields of entertainment.

# Our stage

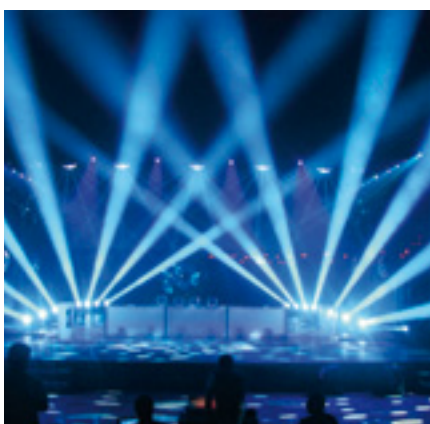
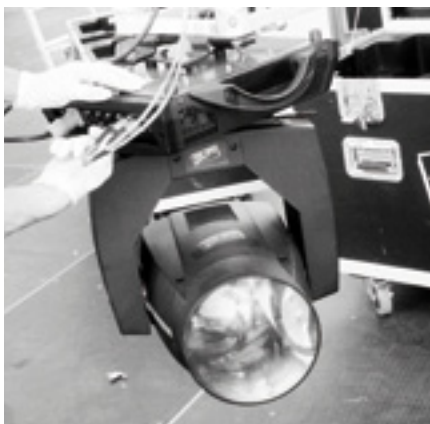

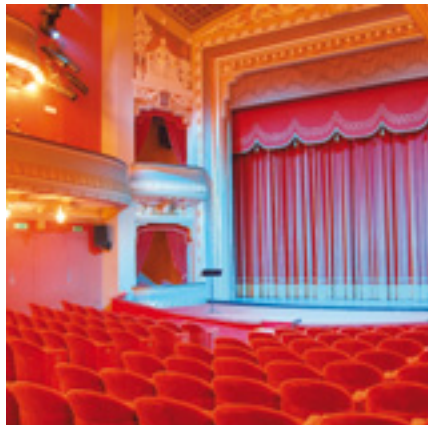

# research



## Smallest and lightest

Alphas 800 and Alphas 700 are the smallest and lightest-weight fixtures in their categories. They weigh only about 20 kg (44 lbs) and their moving head is just 40 centimetres in size. These features originate countless benefits, on all levels. They are extremely easy to handle on stage, to lift and install. They take up very little space on trucks and in warehouse. Thanks to limited space and weight engaged, they leave room for other equipment on trusses and make rigging easier.

Alphas 700 (spot, wash and beam) use the same flight case, which is identical to the Clay Paky Alpha 300 case, another advantage during stage break down and stock handling. Alphas 800 and Alpha Profile 700 are slightly larger, so they fit in the same case of the other fixtures, but they come with a different foam shell.



## Latest generation electronics

The electronics are totally new, with state-of-the-art components, firmware and modular construction. They enhance mechanical performance and improve ease of use. The user can access a full menu through a large display, including: preset macros; an "energy saving" function; remote lamp on/off control; function reset controllable from the lighting desk "autotest" function; Ethernet ready; electronic effect adjustments. The electronics automatically monitor operating parameters and report levels and faults on the display: DMX signal level on each channel, internal temperature, internal control data transmission and encoder and sensor status. A cut-out system switches the unit off in the event of overheating. Thanks to a buffer battery, the configuration display can be operated also without connecting the light to a power line, even when it is still in the flight-case. The user may perform a complete set-up, assign the address and update the firmware by downloading the new version from an uploader or directly from another fixture. The electronic circuit board is universal for all Alpha 800 and 700 versions and its function may be defined by the user through the display. There is also only one firmware that runs all versions.

## Five reasons for a rational choice



### Extraordinarily versatile

Their exceptional brightness, the incomparable speed of their movements, their wide range of effects, the richness of their color system and the silence of their operation are the features that make Alphas 800 and Alphas 700 ideal for use in television studios, theatres, corporate events, concerts and on tours, and both for large and small rental companies. In all these applications, as in fixed installations, small size and light weight are considerable advantages.



### Operating cost saving and sustainability

These 800 and 700 watt luminaires with the light output challenging a 1200 watt unit, in addition to their lightweight and small size, have a modular construction that makes maintenance easier. They are suitable for all kind of shows. Their performance/price ratio is optimal. All these features together mean lower investments, lower running costs, energy saving and respect for the environment, with - what is more - no compromise in terms of luminous efficacy and with the full emotional impact in the light show.



### Extremely easy to use and maintain

Every single feature is designed and engineered bearing in mind the real needs of users at all levels. Riggers, roadies and carriers will be enthusiastic about their ease of handling. Technicians and lighting operators will be seduced by their simplicity of use. The thousands of possible effects will fascinate lighting designers. Maintenance staff will benefit enormously from their constructional standardization and modularity. Lastly accountants will be their first supporters thanks to their cost and management benefits.

# Performance

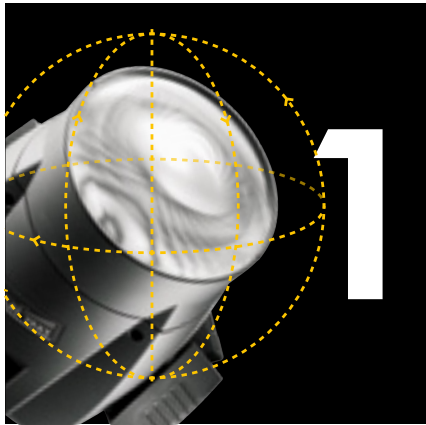

## Fast, very fast, the fastest!

The faster the moving light, the more exciting the show: Alphas 800 and Alphas 700 have no match in this. Their speed is staggering, their acceleration virtually instantaneous and their movements are meticulously precise and perfectly repeatable. This performance is possible thanks to new electronics together with perfect micromechanics, which only Clay Paky can offer. The three-phase motors respond promptly to control signals, giving rise to breathtaking changes in direction. The agility of their movement is enhanced by the small size of their head. Color and gobo changes, prism rotation, zoom changes and strobe effects take place with the same spectacular rapidity. Changes from one level to another are undetectable and sixteen-bit resolution guarantees great accuracy.



## Silence comes as standard

The mechanical movements are totally silent at any speed! That goes for all motorized functions and not just pan and tilt: gobo, color and zoom changes, rotating effects and even extremely high frequency strobe flashing. Cooling fan noise is only 42 dB for Profile 700 model and 47.5 dB in the case of the others. This level drops further when the internal temperature decreases, for example when the lamp is dimmed, since internal sensors automatically reduce fan speed. If you need almost total silence, just choose 400 Watt mode: fans run at minimum and generate 40dB in the case of Profile 700. The quietness of Alphas 800 and Alphas 700 is perfect for theatres, television studios and other applications where silence is a crucial requirement.



## Five reasons for an emotional choice



### Watts that worth much more

The very small-bodied Alphas 800 and 700 generate light beams that beat all competitors of the same power and often exceed lights with much higher rated powers. The legendary superiority of Clay Paky optics is evident in the Alpha 800 and 700's complete, accurate, versatile and powerful optical system. Its efficiency is optimized by superior quality optical components, including a dichroic elliptical reflector that enhances the whole luminous flux emitted by the lamp. This light source is an exclusive quick-release lamp, made specifically for these luminaires according to specifications drawn up by the Clay Paky R&D team. The optical system allows the user to choose between a highly concentrated beam, suitable for bright light projection and mid-air effects, and a wider more uniform light.



### All the effects you need to decorate, amaze and entertain

There is nothing those fixtures cannot do. Every version is enhanced with functions normally found only on the most expensive fixtures. The spot and wash lights have a long zoom range, electronic dimmer and frost filter. The graphic tools are the best you could wish for: all gobos are combinable and made of pure dichroic glass; the rotating prism multiply the beam creating beautiful effects, and the iris is ultra-fast. Alpha Beams 700 are not just automated ACLs, since they create both astounding mid-air effects and rather effective long-distance graphical projections. You do not have to make compromises if you choose an Alpha 800 or an Alpha 700!

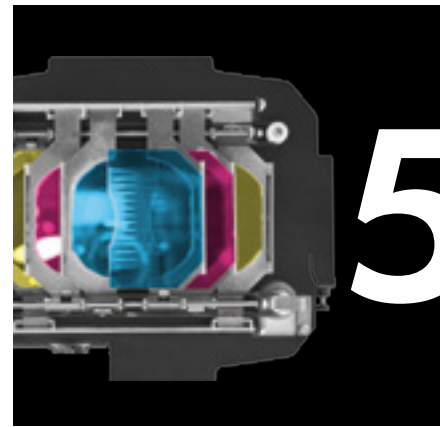

### Rich colors for any mood

At the heart of each Alpha 800 and 700 is the system that colors the light beam, capable of creating a wide range of rich and pastel colors for which Clay Paky has always been famous. The system is based on CMY subtractive color mixing, with dichroic filters selected to cover a large area of the color spectrum. An additional wheel, with eight extremely pure colors plus white, provides special hues frequently required in professional lighting. The change from one color to another is instantaneous; color temperature adjustment is possible thanks to special filters.



2013 Eurovision Song Contest, Sweden  
Photo: Ralph Larmann



Deep Purple



2013 Mediterranean Games



Within Temptation, 2013 Tour



Sky Sports, UK



# ALPHA PROFILE 800 and 700

Profile 800 ST - Code C61385

Profile 700 - Code C61365

The Alpha Profile 800 and Alpha Profile 700 are the only automated spotlights in their categories with framing system available today. Fitted with very bright discharge lamps, they offer a light output comparable and superior to a regular 1200W fixture. The stand-out feature of the Alpha Profile 800 and Alpha Profile 700 is their excellent optical group with 7.6°- 55° zoom and perfectly even projection field. The impressive (patent-pending) 'Stay-Sharp-Zoom' function keeps images in continuous focus while zooming from one beam angle to another, even when projected effects are located on different focal planes. The focal distances have been optimized, so both the edges of the beam blades and the projected image remain perfectly in focus at the same time if required. Programming is enormously simplified, thanks to the color macros and the Dyna-Cue-Creator function, which enables endless combinations of editable graphic effects.

## Endless shaping solutions

The framing system is one of the most advanced beam-shaping devices on the market today. With four independent overlapping blades, designers can now create all manner of triangles and quadrangles of any shape or size. Thanks to a sophisticated micromechanical design, the framed edge of the image remains sharply in focus at the same time as the projected image itself. The exclusive 'curtain effect' (patented) allows gradual total closure of the shape using any one of the four blades. The whole shape may also be rotated up to 90°, either to change its orientation or to keep it fixed as the light beam moves. All movements are smooth and the speed may be adjusted as required.

## Precision linear zoom and dimmer

Alpha Profile 800 and 700 have a very fast zoom with a surprisingly wide aperture range from 11° to 55° (7.6° in extra-run). The dimmer is electronic from 100 to 50% and mechanical from 50% to zero. The dimming curve may be set from a menu. Electronic dimming also leads to energy savings and longer lamp life. Sixteen-bit resolution ensures extra-precise linear control of both functions.

## The Stay-Sharp-Zoom: a dream comes true

Alpha Profile 800 and 700 feature a 'Stay Sharp Zoom' device that keeps images in continuous focus while zooming from one beam angle to another, even when projected effects are located on different fo-

cal planes. The Stay Sharp Zoom device can be turned on and off as required, operating in the range from 11° to 55°, where the zoom is linear. Thanks to this innovative, timesaving function, programming becomes far simpler: a sophisticated algorithm instantaneously and automatically repositions every single lens in the array according to the new zoom beam angle.

## Dyna-Cue-Creator

The Dyna-Cue-Creator function provides a library of dynamic - often three-dimensional - animations that lighting designers find easy to use in their shows. The Dyna-Cue-Creator is the result of meticulous artistic research: the zoom, focus, iris and dimmer functions are combined and synchronized in ways that may be customized by lighting designers (and further combined with colors, gobos, speed and other effects). This is made possible due to the autofocus' extremely rapid and constant adjustments; lighting designers no longer have to program continuous focus corrections with benefits that are particularly evident in complex cues, where the gobo, focus and zoom angles change simultaneously. The 'macros' can be assigned either to individual projectors or applied to groups of projectors. In automatic mode, groups of projectors can be set to play the same macro in a phased sequence - with no need to set the phase shifts manually, as synchronization is controlled automatically by the projector and not from the console.

## As many graphic effects as you like

The Alpha Profile 800 and 700 offer a range of effects that make the light suit-

able for any creative need: 7 interchangeable rotating gobos in dichroic glass, a frost filter which simulates a wash light effect, and a very fast iris, that in addition to changing the beam diameter, can be used as an impressive effect itself.

The built-in CMY color mixing system and additional color wheel (8+white) make it possible to obtain any color. New special colors - particularly sought after in professional use - have been selected for the color wheel.

## An optical unit calibrated for every use

The Alpha Profile 700 uses a very sharp bright 700-watt 7200 K lamp.

The Alpha Profile 800 ST comes indeed with a specially adapted optical unit that lowers the color temperature of the output light beam to 6000 K. This version is therefore ideal for theatrical and television environments, where a warmer light is particularly appreciated.

## Silence! This is theatre

Alpha Profile 800 and 700 have exactly what theatre lighting designers require: an excellent zoom, a versatile shutter system, a full-spectrum color-engine, a small and lightweight body, 16-bit resolution accuracy. Furthermore they are the most silent of all the Alpha fixtures: mechanical movements are totally quiet while the noise generated by cooling fans is extremely low.

## CONTROL CHANNELS

- |                          |                             |                   |
|--------------------------|-----------------------------|-------------------|
| 01. Cyan                 | 17. Blade UP2               | 33. Tilt          |
| 02. Magenta              | 18. Blade DN1               | 34. Tilt fine     |
| 03. Yellow               | 19. Blade DN2               | 35. Function      |
| 04. Linear CTO           | 20. Blade RG1               | 36. Reset         |
| 05. Color Wheel          | 21. Blade RG2               | 37. Lamp control  |
| 06. Color Macro          | 22. Blade LF1               | 38. Pan-Tilt Time |
| 07. Stop/Strobe          | 23. Blade LF2               | 39. Color Time    |
| 08. Dimmer               | 24. Framing System Rotation | 40. Beam Time     |
| 09. Dimmer fine          | 25. Focus                   | 41. Gobo Time     |
| 10. Iris                 | 26. Focus fine              |                   |
| 11. Rotating Gobo Change | 27. Zoom                    |                   |
| 12. Gobo Rotation        | 28. Autofocus distance      |                   |
| 13. Gobo fine            | 29. Autofocus adjustment    |                   |
| 14. Prism                | 30. Macro effects           |                   |
| 15. Frost                | 31. Pan                     |                   |
| 16. Blade UP1            | 32. Pan fine                |                   |

## WEIGHT AND DIMENSIONS (mm - inches)

■ 31,5 Kg (69 lbs 5 oz)

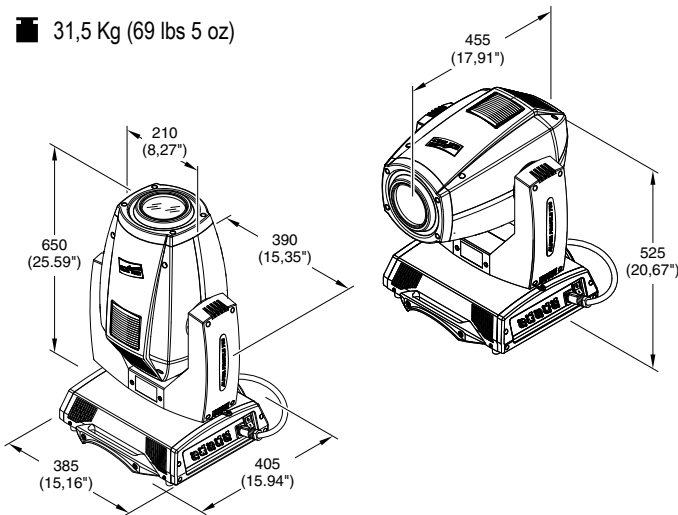

## ROTATING GOBOS $\varnothing$ 25.7 mm, image $\varnothing$ 23.5 mm

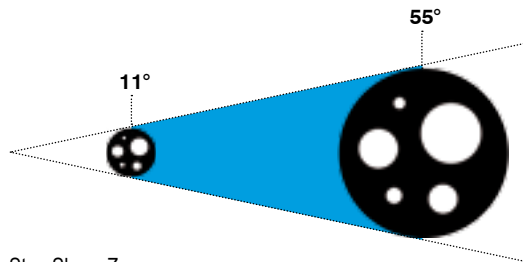

**Stay-Sharp-Zoom:**  
the operator no longer has to worry about losing the sharpness of the projection.

## ALPHA 800 and 700 PHOTOMETRICS

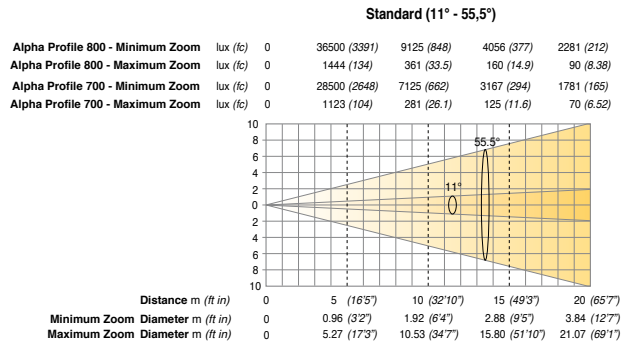

In "Half-Power mode" the luminosity is 65% of the above values (Function available only on Profile 700)

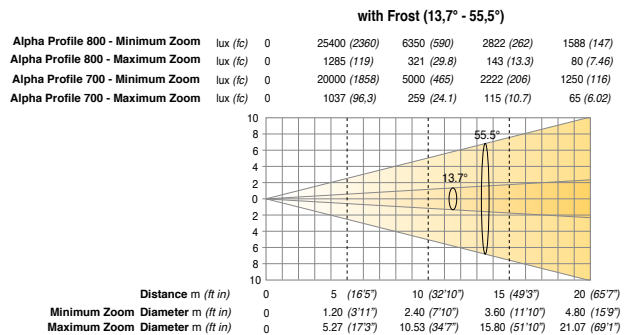

In "Half-Power mode" the luminosity is 54% of the above values (Function available only on Profile 700)

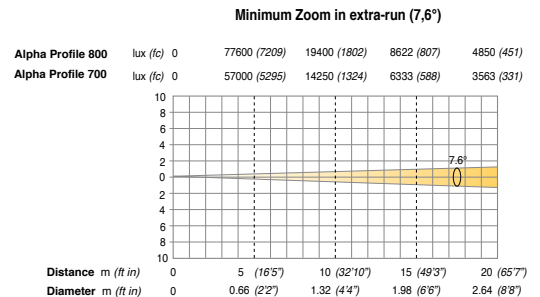

In "Half-Power mode" the luminosity is 53% of the above values (Function available only on Profile 700)

## COLOR WHEEL

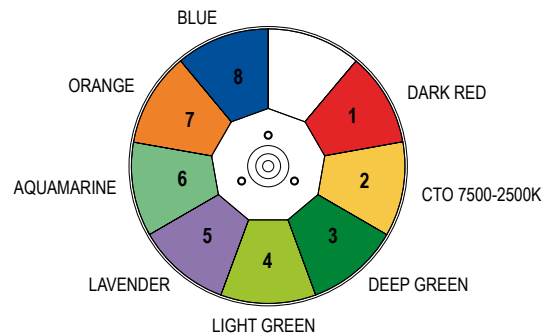

# DYNA CUE CREATOR

The "Dyna-Cue-Creator" function opens doors for lighting designers to a universe of spectacular, creative solutions.

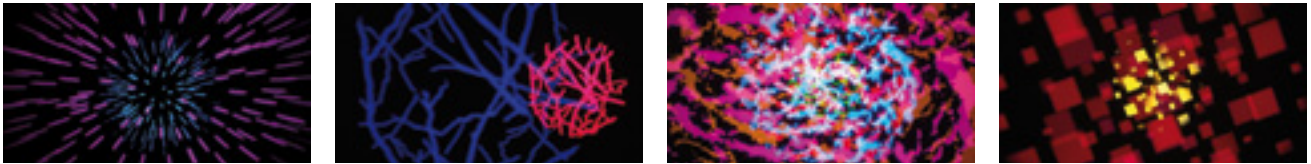

# FRAMING SYSTEM

framing system rotation on 90°

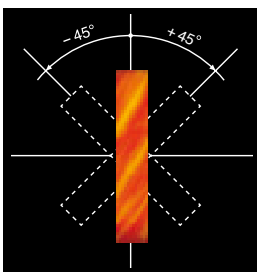

Alpha Profile 800 and 700 feature a precision micromechanics framing system that ensures perfect repeatability and does away with continuous manual adjustments.

		square	rectangle	diamond
triangle	slice	curtain 1	half circle	curtain 2
open curtain	closed curtain	ribbon	square-corner trapezium	trapezium

# EXAMPLES OF FRAMING SYSTEM APPLICATIONS



Musical "1789", France



Mediaset TV Studio, Italy





# ALPHA SPOT QWO 800

QWO 800 - Code C61380  
QWO 800 ST - Code C61381

The Alpha Spot QWO (Quality Wide Optics) uses the brand new 800-watt FastFit MSR Platinum lamp. This lamp is widely appreciated for its brightness, which is higher than that of previous generation 1200-watt lamps, and its unique ability to increase color contrast and details, allowing crisper and more precise graphic effects than have ever been seen before. The "QWO 800" also offers some truly special optical features, which make it one of the top lights in its category: first of all, an extremely wide zoom (7.6° -55°), which makes it suitable for both short and long distance projections. The optical unit, developed in the Clay Paky laboratories, ensures utmost projection uniformity. It has also been enhanced with a Stay-Sharp-Zoom device, which automatically keeps the projected image in focus when switching between two beam angles and even when switching between two gobo wheels.

## A complete set of effects and high quality equipment

The effects provided with the Alpha Spot QWO 800 leave nothing to desire: fifteen glass gobos on two wheels (one with rotating gobos), an animation disc and a rotating 6-facet prism. There are obviously all the usual tools needed to color the light as desired: CMY system, wheel with standard and special colors and linear CTO system.

The beam itself can be further shaped with a special very fast iris, with sixteen blades that join up the edges excellently during hard-edge projections. A progressive frost filter is also available for soft-edge projections. Dimming is accurate thanks to a hybrid (mechanical and electronic) device.

## It is an ingenious tool for quickly creating artistic effects

Using all the Alpha Spot QWO 800's effects is made easy with a Dyna-Cue-Creator, a formidable tool that not only speeds up programming, but also makes it possible to combine and synchronize different effects automatically, which would otherwise be complex to program. The Dyna-Cue-Creator transforms the "macro" channel into a collection of true dynamic animations, which are often three-dimensional. Lighting design-

ers can use them in their shows "off the shelf": the zoom, focus, iris and dimmer functions are combined together in different ways, which lighting designers may customize by adding other parameters of their choice (colors, gobos, speed and others). What makes the Dyna-Cue-Creator easy to use is the new Alpha autofocus: lighting designers no longer need to adjust the image continuously, which is a marvellous advantage in complex scenes, where the gobo, focal plane and beam angle may all change simultaneously.

## Top-ranking silence for use in the most professional environments

The Alpha Spot QWO 800 is one of the quietest moving lights in existence. This feature is one of the main requirements demanded by exacting professionals who work in the theatre, television, and for corporate events, where the disturbance factor is important when choosing lights.

## Small, similar in size to a compact light

The QWO 800 is very small for its power category, which makes it more convenient to handle and install, keeps investments down, decreases operating costs, saves energy and respects the environment.

Of course, this also makes for surprisingly agile movements, thus enhancing the quality and quantity of the QWO 800's effects and functions, which are more typical of higher category lights with much larger dimensions.

## The most versatile and complete light on the market

Small size and weight, wide zoom range, excellent light beam brightness and brilliance, uniformity at every beam angle, silent operation and low energy consumption are the features that make the Alpha Spot QWO 800 a particularly suitable light for installation in studios, theatres, exhibitions, shopping centres and the most demanding environments.

## Alpha Spot QWO 800 - "ST" Version

Clay Paky introduced the "ST" version to meet the specific needs of certain theatre and television lighting designers, who require a naturally "warm" beam, regardless of the brightness of the light.

Consequently, the Alpha Spot QWO ST 800 is equipped with a modified optical unit that lowers the color temperature of the output light beam and brings it near to the performance of a halogen light.

## CONTROL CHANNELS

- |                              |                             |
|------------------------------|-----------------------------|
| 01. Cyan                     | 19. Animation Disc Rotation |
| 02. Magenta                  | 20. Focus                   |
| 03. Yellow                   | 21. Focus fine              |
| 04. Linear CTO               | 22. Zoom                    |
| 05. Color Wheel              | 23. Autofocus distance      |
| 06. Color Macro              | 24. Autofocus adjustment    |
| 07. Stop/Strobe              | 25. Macro effects           |
| 08. Dimmer                   | 26. Pan                     |
| 09. Dimmer fine              | 27. Pan fine                |
| 10. Iris                     | 28. Tilt                    |
| 11. Static Gobo Change       | 29. Tilt fine               |
| 12. Rotating Gobo Change     | 30. Function                |
| 13. Gobo Rotation            | 31. Reset                   |
| 14. Gobo Fine                | 32. Lamp control            |
| 15. Prism Insertion          | 33. Pan-Tilt Time           |
| 16. Prism Rotation           | 34. Color Time              |
| 17. Frost                    | 35. Beam Time               |
| 18. Animation Disc Insertion | 36. Gobo Time               |

## WEIGHT AND DIMENSIONS (mm - inches)

■ 32 Kg (70 lbs 5 oz)

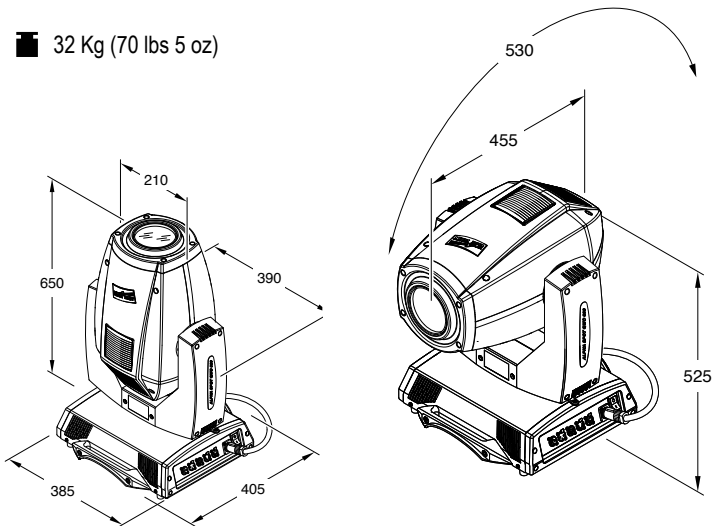

## PHOTOMETRICS

Standard (11° - 55°) - 800W

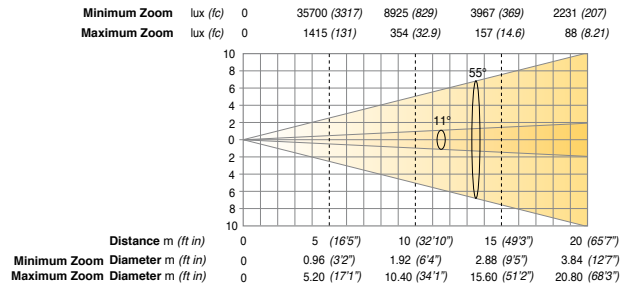

with Frost (12.6° - 55°) - 800W

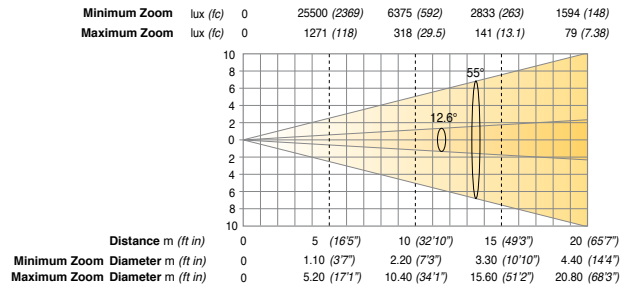

Minimum Zoom in extra-run (7.6°) - 800W

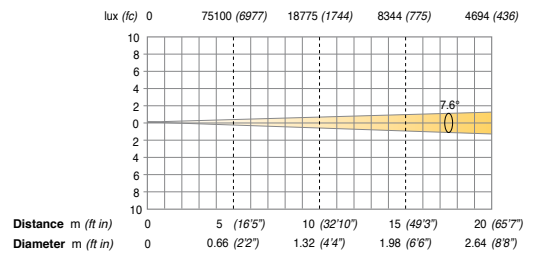

### STATIC GOBOS

Ø 31.5 mm, image Ø 23 mm



### ROTATING GOBOS

Ø 25.7 mm, image Ø 23 mm

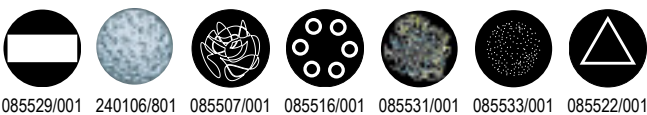

### COLOR WHEEL

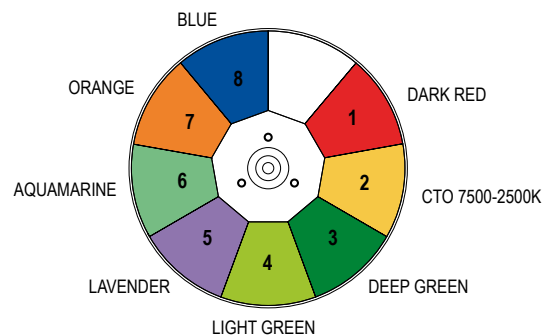

## DYNA CUE CREATOR

The "Dyna-Cue-Creator" function opens doors for lighting designers to a universe of spectacular, creative solutions.

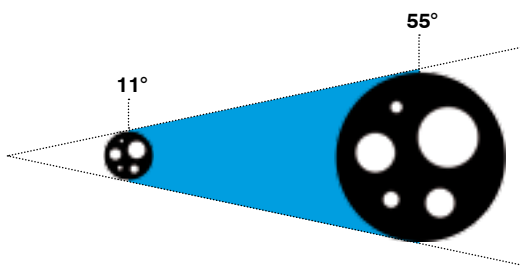
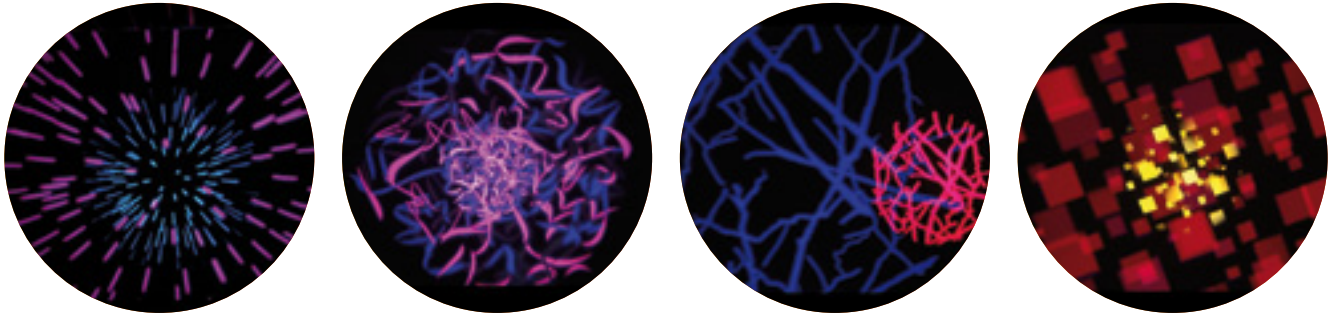

Stay-Sharp-Zoom:  
the operator no longer has to worry about losing the sharpness of the projection.



2013 Berlin Summer Rave - Photo: AHolmes



Star Factory, Ukraine

2013 Eurovision Song Contest, Sweden  
Photo: Ralph Larmann





# ALPHA SPOT HPE 700

Code C61355

With the Alpha Spot HPE 700, a new generation of “moving heads” for graphic effects is born. This luminaire combines spectacular effects, ease of daily use, simple operation and environmental sustainability. The 700 watt lamp provides a level of brightness equal, if not greater, than that seen with higher wattages. The small and light-weight body houses an array of optical and graphic devices that have nothing to envy from more sophisticated fixtures, including a zoom with electronic focus and electronic dimmer. The frost effect and its extraordinary brightness allow this spotlight to be used in the place of a washlight. The keywords for Alpha Spot HPE 700 are: full beam control, complete range of graphic effects, brightness, speed, low energy consumption and versatile use.

## A light beam making all graphic effects sharp and bright

Decorative projection is without a doubt more impressive when images are bright their edges clear and well defined. For this purpose, the Alpha Spots HPE 700 feature a special optical system and dichroic elliptical reflector with high luminous efficiency that collect and concentrate the flux emitted by the new FastFit 700W lamp, intentionally creating a “hot-spot” effect with no less than 33,000 lx at five meters. However, if necessary, a separate lens can be inserted to soften the beam with a more “uniform field”, for example in less brightly lit scenes.

## Breathtaking speed

The Alpha Spot HPE 700 is as nervous as a colt. This spotlight has been designed to amaze for the agility of its movements and the readiness with which it responds to controls. The incomparable speed of the three-phase motors is used to the full in this version. Not only do they produce extremely fast pans (2.75 s / 540°) and tilts (1.65 s / 250°), but also instantaneous “snapshot” transitions from one effect to another (gobo, iris and zoom) and impressive bi-directional rotations (prisms and gobos). Furthermore sixteen-bit resolution guarantees absolute precision and reproducibility.

## Precision linear zoom and dimmer

Alpha Spots HPE 700 have a very fast linear zoom with wide linear range from 14.7° to 47°. The dimmer is electronic from 100 to 50% and mechanical from 50% to zero, and is perfectly linear. Electronic dimming leads to savings in consumption and longer lamp life. Sixteen-bit resolution ensures extra-precise control.

## Beautiful colors

The built-in CMY system and the additional color wheel (8+white) make any color possible. Special new colors, particularly demanded for professional use, have been selected for the color wheel.

## High quality devices for projections and mid-air effects

Despite their small size, Alpha Spots HPE 700s provide a vast range of effects, able to satisfy every creative requirement. Their fifteen interchangeable gobos (seven rotating plus eight fixed) are all made from high quality textured dichroic glass, and fitted on two wheels that can be combined for a high impact morphing effect. The highly transparent rotating prism allows fairly large surfaces to be decorated with dynamic and highly atmospheric effects. The frost filter is so effective that it emulates a washlight. Finally the iris is so fast that it can be used as an effect in its own right.

	5m	10m	15m	20m
■ Alpha Spot HPE 700	33,000	8,250	3,667	2,063
● Alpha Spot HPE 1200	24,700	6,150	2,744	1,543
▲ Alpha Spot HPE 575	9,233	2,308	1,026	577

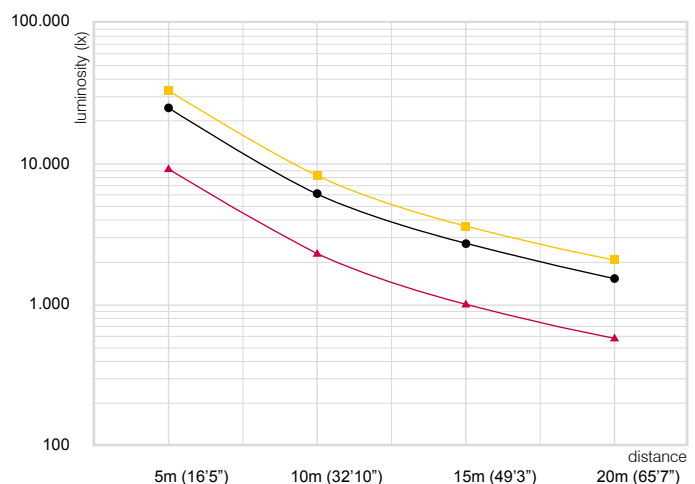

Luminosity at the centre of the beam for 3 Alpha Spot HPE models according to distance (14.7° aperture)

## CONTROL CHANNELS

- |                          |                   |
|--------------------------|-------------------|
| 01. Cyan                 | 16. Frost         |
| 02. Magenta              | 17. Focus         |
| 03. Yellow               | 18. Linear Zoom   |
| 04. Uniform field lens   | 19. Pan           |
| 05. Color Wheel          | 20. Pan Fine      |
| 06. Stop/Strobe          | 21. Tilt          |
| 07. Dimmer 0-100%        | 22. Tilt Fine     |
| 08. Dimmer Fine          | 23. Function      |
| 09. Iris                 | 24. Reset         |
| 10. Static Gobo Change   | 25. Lamp control  |
| 11. Rotating Gobo Change | 26. Pan-Tilt Time |
| 12. Gobo rotation        | 27. Color Time    |
| 13. Gobo Fine            | 28. Beam Time     |
| 14. Prism                | 29. Gobo Time     |
| 15. Prism rotation       |                   |

## WEIGHT AND DIMENSIONS (mm - inches)

■ 22,9 Kg (50 lbs 6 ozs)

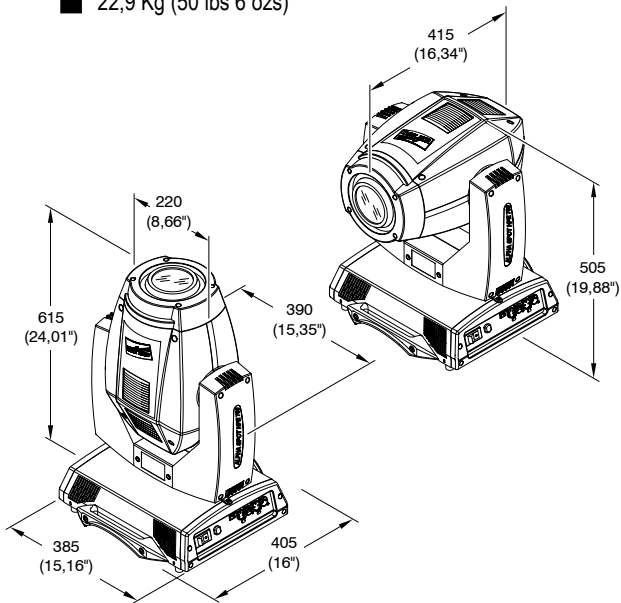

## PHOTOMETRICS

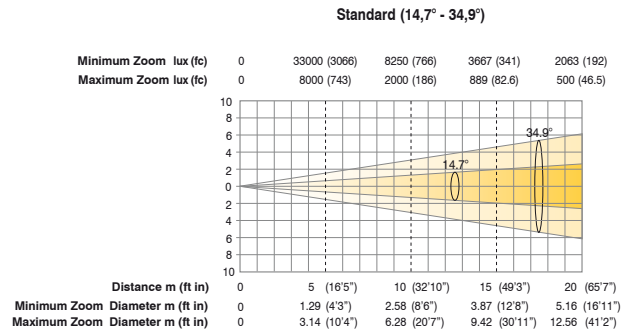

In "Half-Power mode" the luminosity is 53% of the above values

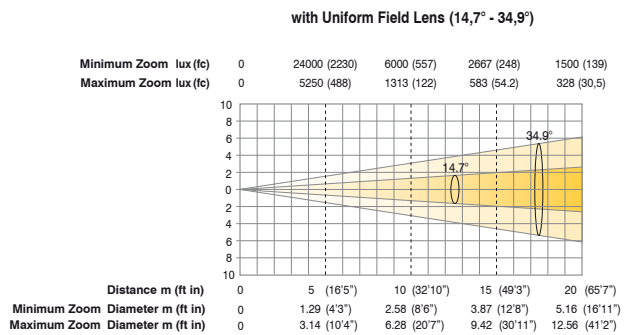

In "Half-Power mode" the luminosity is 51% of the above values

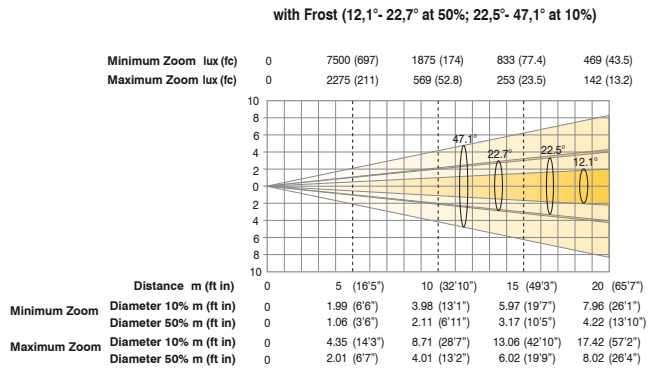

In "Half-Power mode" the luminosity is 45% of the above values

Diameter 10%-50%: beam diameter for 10% and 50% of maximum illumination.

### STATIC GOBOS

Ø 31.5 mm, image Ø 23 mm



### ROTATING GOBOS

Ø 25.7 mm, image Ø 23 mm

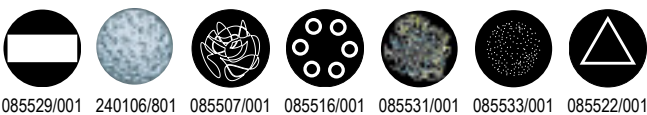

### COLOR WHEEL

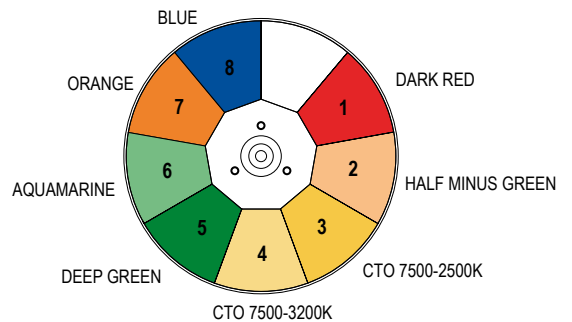

# ALPHA 700 | 800

Profile | Spot HPE | Beam | Wash | Profile | QWO



*small*





# ALPHA BEAM 700

Code C61360

The Alpha Beam 700 is a special unique luminaire, conceived as an automated ACL to create parallel light beams visible even in the brightest scenes. However its extensive range of effects makes it the most versatile of the Alphas 700. First and foremost, thanks to its rotary gobos and prism, it generates extremely bright beams with amazing dynamic mid-air effects. At the same time, its high quality optical components with focusing can project sharp gobo patterns even at long distances. Lastly, its frost filter can transform the Alpha Beam 700 into an extremely efficient washlight able to “reinforce” other color changers. Its beam can be moved extremely fast on the stage, on the audience and into the sky during open air events. It can be an exciting blinder or a striking dynamic color-changing sky-tracker.

## A concentrated beam with never-seen-before brightness

This small luminaire, fitted with a 700 watt only lamp, produces a light beam that is so concentrated and powerful it leaves you stunned: 100,000 lx at ten meters! The beam reaches several hundred meters with its 6.6° aperture, and is visible at great distances. It stands out from any background, even when there are powerful video screens or other extremely bright equipment on stage.

## Incredible versatility

Alpha Beams 700 may be used perfectly well as real spotlights with fixed or rotating images. They are particularly suitable for projecting images at considerable distances. The fixtures are equipped with electronic focusing for sharp and clear projection, with or without rotating prism. They are also fitted with a linear frost effect created with special micro-lenses; when this frost effect is used on a simple colored light beam, a perfectly uniform field is achieved that has nothing to envy

from a specialized washlight.

## An incomparable number of spectacular mid-air effects

Seven rotating and eight fixed gobos (all interchangeable) with carefully chosen patterns mean the shape of the light beam can be “molded” to taste. The iris does not only adjust the beam diameter, but adds a further effect to the show thanks to its extremely high speed. A rotating prism transforms the concentrated beam into a shower of light similar to the well known “moon-flower” effect.

## Breathtakingly fast movements and effects

Unlike a fixed Par64 ACL, the Alpha Beam 700 is a moving head in all respects: thanks to its three-phase motors, beam movement speed and acceleration are considerably higher, and its reaction time to the control signal is striking.

## Absolutely nothing is missing . . .

Needless to say the Alpha Beam 700 also has a CMY mixing system, an eight color wheel plus white, two CTO filters (3,200 K and 2,500 K) and a CTB filter to adjust color temperature, a linear dimmer from 0 to 100% (electronic and mechanical) and a shutter-strobe on a separate channel.

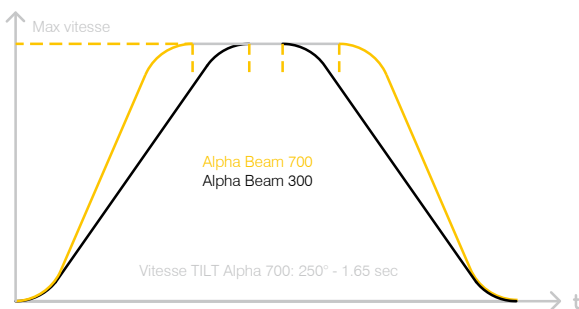

All 700 luminaires reach the maximum speed much quicker than any other light

## CONTROL CHANNELS

- |                          |                    |
|--------------------------|--------------------|
| 01. Cyan                 | 14. Linear Frost   |
| 02. Magenta              | 15. Focus          |
| 03. Yellow               | 16. Pan            |
| 04. Color Wheel          | 17. Pan Fine       |
| 05. Stop/Strobe          | 18. Tilt           |
| 06. Dimmer 0-100%        | 19. Tilt Fine      |
| 07. Dimmer Fine          | 20. Function       |
| 08. Iris                 | 21. Reset          |
| 09. Static Gobo Change   | 22. Lamp control   |
| 10. Rotating Gobo Change | 23. Pan -Tilt Time |
| 11. Gobo rotation        | 24. Color Time     |
| 12. Prism insertion      | 25. Beam Time      |
| 13. Prism rotation       | 26. Gobo Time      |

## WEIGHT AND DIMENSIONS (mm - inches)

20,8 Kg (45 lbs 12 ozs)

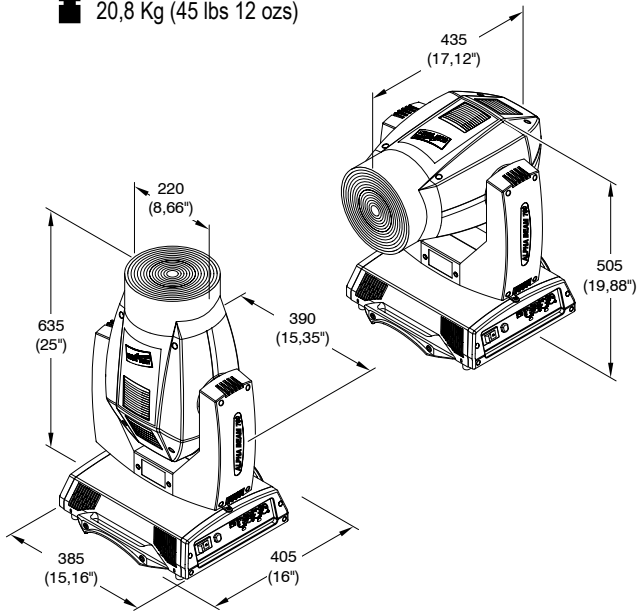

## STATIC GOBOS

Ø 31.5 mm

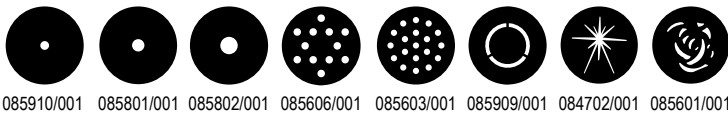

## ROTATING GOBOS

Ø 25.7 mm, image Ø 23 mm



## PHOTOMETRICS

### Standard (6.6°)

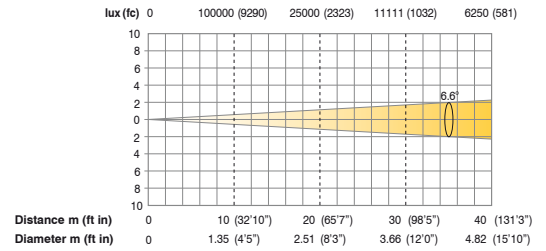

In "Half-Power mode" the luminosity is 60% of the above values

### with Frost (6.7° at 50% - 15.6° at 10%)

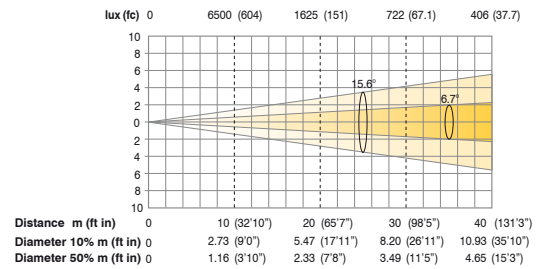

In "Half-Power mode" the luminosity is 48% of the above values

Diameter 10%-50%: beam diameter for 10% and 50% of maximum illumination.

## COLOR WHEEL

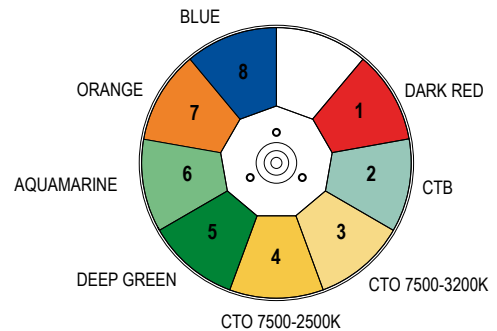

# ALPHA 700 | 800

Profile | Spot HPE | Beam | Wash | Profile | QWO



*light*



# ALPHA WASH 700

Code C61350

If you are looking for a powerful and - at the same time - small lightweight washlight, the Alpha Wash 700 is the most modern response to your requirements. The new 700W FastFit lamp ensures incomparable brightness for its category. The choice of colors and shades is virtually limitless. An optical unit with extremely high luminous efficiency and a long-range zoom ensure perfect color uniformity at all apertures. Thanks to cutting-edge electronics, movements are accurate and very gentle, and changes in aperture and effects are instantaneous. General operation is extremely silent. Its compact size makes the Alpha Wash 700 virtually invisible on the scene.

## An extremely bright uniform field, with aperture that may be adjusted to taste

The Alpha 700 provides about 95,000 lux at five meters in the centre of the beam. The light is well distributed over the whole projection surface. A perfectly linear zoom allows the aperture to be adjusted from 9°-50° and ensures a uniform beam at all distances at the same time maintaining maximum luminous efficiency. The zoom can move instantaneously or be extremely slow and smooth.

## An unlimited choice of very beautiful colors

The color generation system consists of a CMY group and one wheel with eight colors + white, with a selection of special colors that are often required in professional lighting use: orange, light green, dark green, aquamarine, lavender, deep

blue (night light effect), and a beautiful saturated red. There is also a CTB filter for adjusting color temperature. Changes from one color to another are instantaneous. A linear CTO device allows color temperature correction from 7500 K to 3200 K, thus greatly widening the color range available and making the light perfectly adaptable to any other light sources found on the scene.

## Two rotary beam shapers for changing the shape of the beam

Two special lenses are available to modify beam diffusion: a beam ovalizer and a lens with "diamond tip" effect. Both may be rotated with indexed positioning or rotate continuously with adjustable speed, thus adding an un-usual "fluid" effect (amplifiable with the zoom) to the wash projection.

## Motorized top hat

The Alpha Wash 700 features a motorized top hat to eliminate parasite light emissions. It moves in synchrony with the zoom and it disappears automatically inside the fixture's body. The top hat is highly appreciated especially in theatres and television studios; its mechanical sophistication is clear evidence that the Alpha 700 has been designed without compromise.

## A highly accurate dimmer

The Alpha 700 Wash dimmer is the most accurate you will ever need. It operates on two dedicated channels (dimmer + dimmer fine). It is electronic from 100 to 50%, i.e. the lamp is dimmed directly thus reducing energy consumption, internal temperature and noise. From 50% to zero dimming is mechanical and linear.



Motorized top hat

## CONTROL CHANNELS

- |                            |                    |
|----------------------------|--------------------|
| 01. Cyan                   | 12. Pan            |
| 02. Magenta                | 13. Pan Fine       |
| 03. Yellow                 | 14. Tilt           |
| 04. Linear CTO             | 15. Tilt Fine      |
| 05. Color Wheel            | 16. Function       |
| 06. Stop/Strobe            | 17. Reset          |
| 07. Dimmer 0-100%          | 18. Lamp control   |
| 08. Dimmer Fine            | 19. Pan -Tilt Time |
| 09. Beam shapers insertion | 20. Color Time     |
| 10. Beam shapers rotation  | 21. Beam Time      |
| 11. Linear Zoom            |                    |

## WEIGHT AND DIMENSIONS (mm - inches)

20.6 Kg (45 lbs 5 ozs)

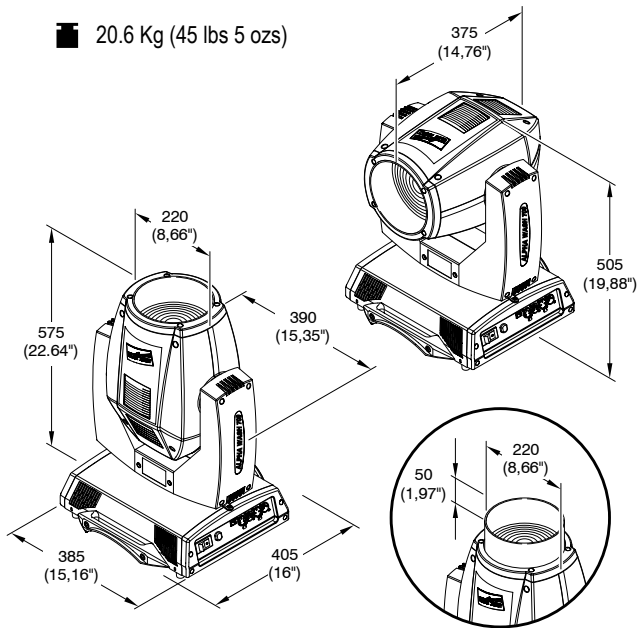

## COLOR WHEEL

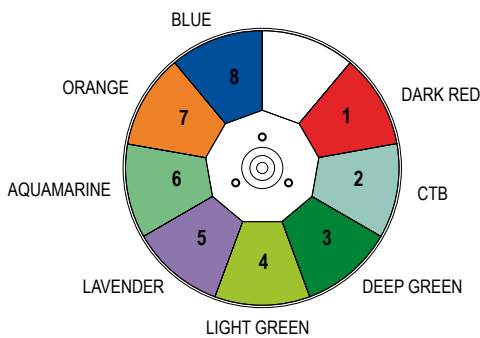

## PHOTOMETRICS

Standard (4,1° - 30,0° at 50%; 9,2° - 51,7° at 10%)

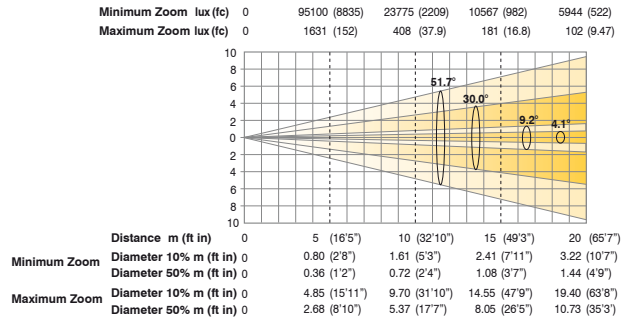

In "Half-Power mode" the luminosity is 58% of the above values

with ovalizer filter (X axis): 10,5° - 35,7° at 50%; 28,8° - 63,2° at 10%

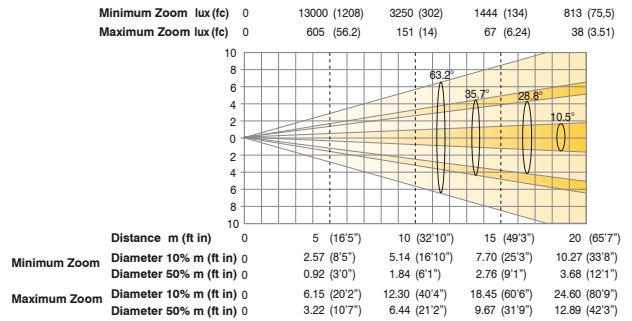

In "Half-Power mode" the luminosity is 44% of the above values

with ovalizer filter (Y axis): 5,3° - 23,6° at 50%; 12,0° - 44,7° at 10%

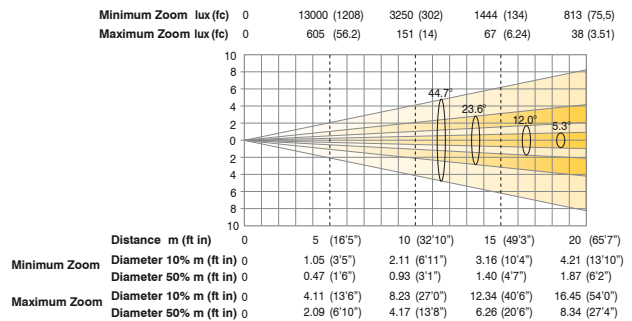

In "Half-Power mode" the luminosity is 44% of the above values

Diameter 10%-50%: beam diameter for 10% and 50% of maximum illumination.

# ALPHA 700 | 800

Profile | Spot HPE | Beam | Wash | Profile | QWO



*fast*





# CONSTRUCTION FEATURES

## BODY

- Aluminium structure with die-cast composite plastic fireproof cover.
- Two side handles for transportation.
- Device locking PAN and TILT mechanisms for transportation and maintenance.

## SAFETY DEVICES

- Bipolar circuit breaker with thermal protection.
- Automatic break in power supply in case of overheating.
- Forced ventilation with axial fans

## WORKING POSITION

- Functioning in any position.

## LAMPS



**Code L10098**

### 700W Discharge Lamp (7200K)

supplied with Profile 700, Spot HPE 700, Beam 700, Wash 700

**Code LAM003**

### 700W Discharge Lamp (5600K)

optional

**Code L10105**

### 800W Discharge Lamp (7500K)

supplied with Profile 800 ST, Spot QWO 800, Spot QWO 800 ST (In the "ST Versions" the color temperature of the beam light emission is 6000K)

## WEB SERVER

Web Server is an application that opens the entire menu on a computer, providing helpful information such as lamp working hours, software version and other information already directly accessible in the projector menu. It can be used to change DMX address and standard operating options.

Using the Web Server, the firmware can be updated directly from a computer. Just connect the projector to any computer using an Ethernet cable, and follow the instructions (go to [www.claypaky.it/en/download](http://www.claypaky.it/en/download) and select "web server" in the drop-down menu).

## CE MARKING

In conformity with the European Union Low Voltage Directive 2006/95/CE and Electromagnetic compatibility Directive 2004/108/CE.

## MOVING BODY

	Angle	Max speed	Resolution
PAN	540°	3.15 sec (Std) 2.75 sec (Fast)	2.11° (PAN fine=0.008°)
TILT	250°	1.95 sec (Std) 1.65 sec (Fast)	0.98° (TILT fine=0.004°)

Automatic repositioning of PAN and TILT after accidental movement not controlled by control unit.

## OMEGA

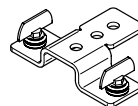

**Code 183102/802**

for clamps fixing, supplied (2 pieces)

## HIGH QUALITY ROXTER-CASES

for 2 Alpha 800s or 700s, equipped with wheels.  
Contain 2 foam shells.

Model	Flight Case	Foam Shell
<b>HPE 700 Beam 700 Wash 700</b>	<b>code F21205</b>	<b>code F21172</b>
<b>Profile 700 Profile 800 QWO 800</b>	<b>code F21207</b>	<b>code F21177</b>



TECHNICAL DATA	ALPHA PROFILE		ALPHA SPOT QWO		ALPHA SPOT HPE 700	ALPHA BEAM 700	ALPHA WASH 700
	800 ST	700	800	800 ST			
Lamp type	800W disch.	700W disch.	800W discharge		700W discharge	700W discharge	700W discharge
- Light Beam Color Temperature (K)	6,000	7,200	7,500	6,000	7,200	7,200	7,200
- Luminous Flux (lm)	55,000	50,000	55,000		50,000	50,000	50,000
- Average Life (h)	750		750		750	750	750
- Cap	PGJX28		PGJX28		PGJX28	PGJX28	PGJX28
Power supplies available	100-240V 50/60Hz		100-240V 50/60Hz		100-240V 50/60Hz	100-240V 50/60Hz	100-240V 50/60Hz
Input Power	1200VA at 230V 50Hz	1050VA at 230V 50Hz	1200VA at 230V 50Hz		1,050VA at 230V 50Hz	1,050VA at 230V 50Hz	1,050VA at 230V 50Hz
Electronic Ballast	•		•		•	•	•
Lamp controlled from the Lighting desk	•		•		•	•	•
Electronic Linear Zoom	11° - 55°		11° - 55°		14.7°- 47°		9°-50°
Motorized Top Hat							•
Electronic Focusing	•		•		•	•	
Stay-Sharp-Zoom (autofocus)	•		•				
Uniform Field Lens					•		
Dyna-Cue-Creator	•		•				
CMY color mixing	•		•		•	•	•
Linear CTO	•		•				•
Color Wheel	1 (8 colors + white)		1 (8 colors + white)		1 (8 colors + white)	1 (8 colors + white)	1 (8 colors + white)
CTO filter(s)	1 (2,500K)		1 (2,500K)		2 (2,500K and 3,200K)	2 (2,500K and 3,200K)	
CTB filter						•	•
Linear Frost	•		•			•	
Fixed Frost					•		
Rotating Gobos (indexable and interchangeable)	7		7		7	7	
Static Gobos (interchangeable)			8		8	8	
Morphing Effect			•		•		
Rotating Prisms	1 (9-facet)		1 (6-facet)		1 (5-facet)	1 (6-facet)	
Framing system	•						
90° rotation of the framing system	•						
Rotating Beam Shapers							• (2)
Mechanical High speed Iris	•		•		•	•	
0-100% dimmer on a dedicated channel	•		•		•	•	•
Stop/strobe	•		•		•	•	•
Long-life self charging battery	•		•		•	•	•
Preset macros	•		•		•	•	•
Function reset from control unit	•		•		•	•	•
"Autotest" routine	•		•		•	•	•
Ethernet-ready	•		•		•	•	•
Web server connectivity	•		•		•	•	•
Electronic monitoring of all parameter status with Error alarm	•		•		•	•	•
Cooling system monitoring	•		•		•	•	•
DMX level monitoring on all channels	•		•		•	•	•
Internal data transmission diagnostics	•		•		•	•	•
Firmware upgrade with no need of connection to power	•		•		•	•	•
Firmware upload from another fixture	•		•		•	•	•
Switchable Power supply	automatic		automatic		automatic	automatic	automatic
PAN and TILT lock on 4 and 7 positions respectively	•		•		•	•	•
Silent Version (SV)	•		•		•	•	•
DMX control channels	max 41		max 36		max 29	max 26	max 21
Weight (Kg/lbs)	31,5 (69 lbs 5 ozs)		32 (70 lbs 5 ozs)		22,9 (50 lbs 6 ozs)	20,8 (45 lbs 12 ozs)	20,6 (45 lbs 5 ozs)
Dimensions LxWxH (mm/inches)	385x405x650 (15.16"x16"x25.6")		385x405x650 (15.16"x16"x25.6")		385x405x615 (15.16"x16"x24.01")	385x405x635 (15.16"x16"x25")	385x405x575 (15.16"x16"x22.64")

# ALPHA 700 | 800

Profile | Spot HPE | Beam | Wash | Profile | QWO



*bright*



[www.claypaky.it](http://www.claypaky.it)

CLAY PAKY S.p.A.  
I - 24068 Seriate (BG) - Via Pastrengo, 3/b  
Phone +39 035 654311 - Fax +39 035 301876  
[www.claypaky.it](http://www.claypaky.it) - [cp.info@claypaky.it](mailto:cp.info@claypaky.it)



UNI EN ISO 9001